

# FBC - Outswing Folding Door (E4 Hardware)

Exterior Elevation

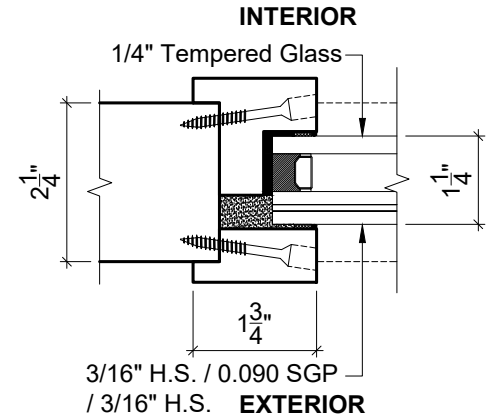
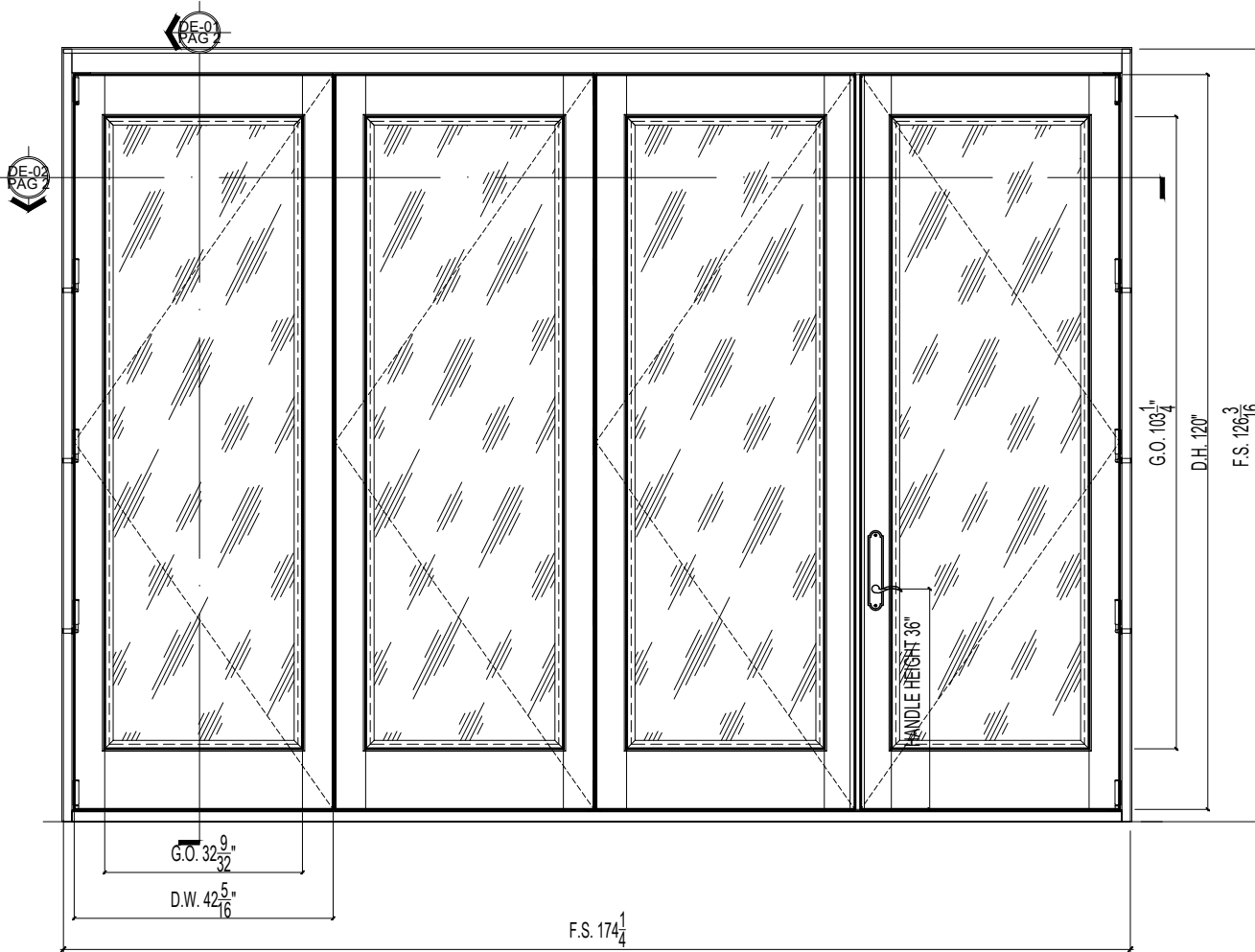

## OUTSWING FOLDING DOOR (E4 HARDWARE)

In compliance with the Florida Building Code  
for HVHZ [FL14329-R2](#)

- Thickness: 2 1/4"
- Jamb Depth: 6 9/16"
- Glass: 1 1/4" IG LAMINATED  
IMPACT GLAZING
- Hardware: Centor E4 Sill System &  
KFV multipoint Lock
- Wood: Mahogany

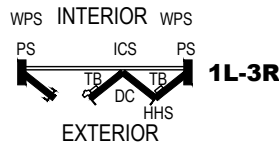
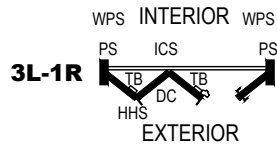

# FBC - Outswing Folding Door (E4 Hardware)

Assembly details

